

These measurements refer to the frame work and do not include upholstery, seam or zip

Tolerances (mm)			
Dimension		Deviation	
(1)	-	20	±0,2
(20)	-	50	±0,5
(50)	-	200	±1,0
(200)	-		±2,0

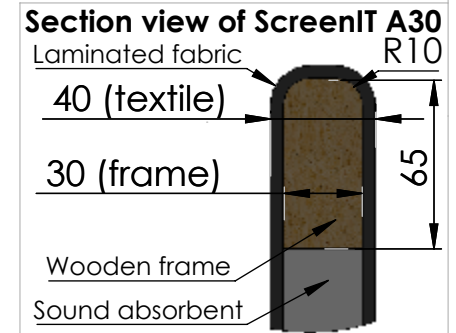

DETAIL A
SCALE 1 : 5
x6

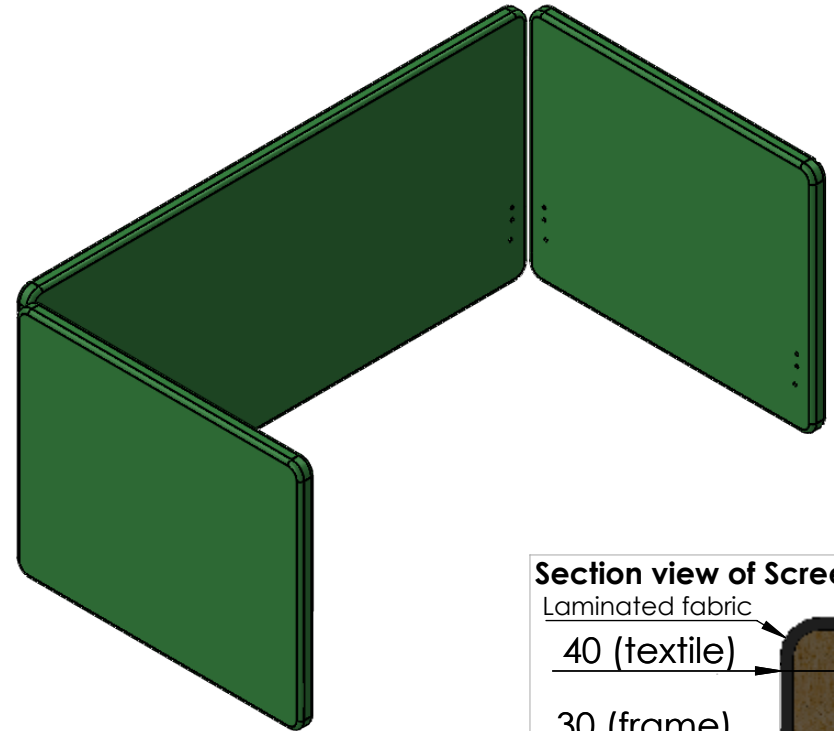
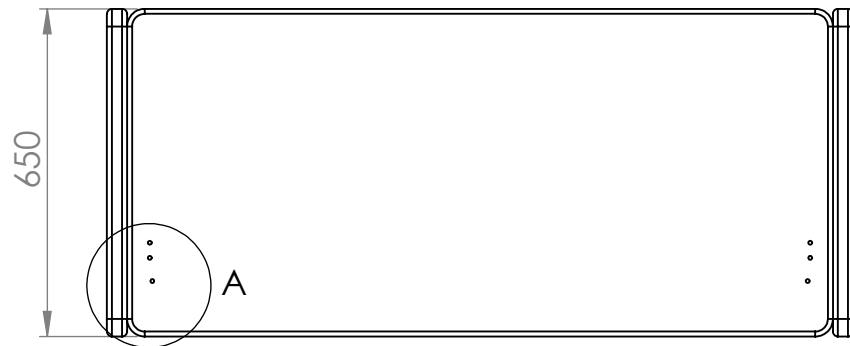
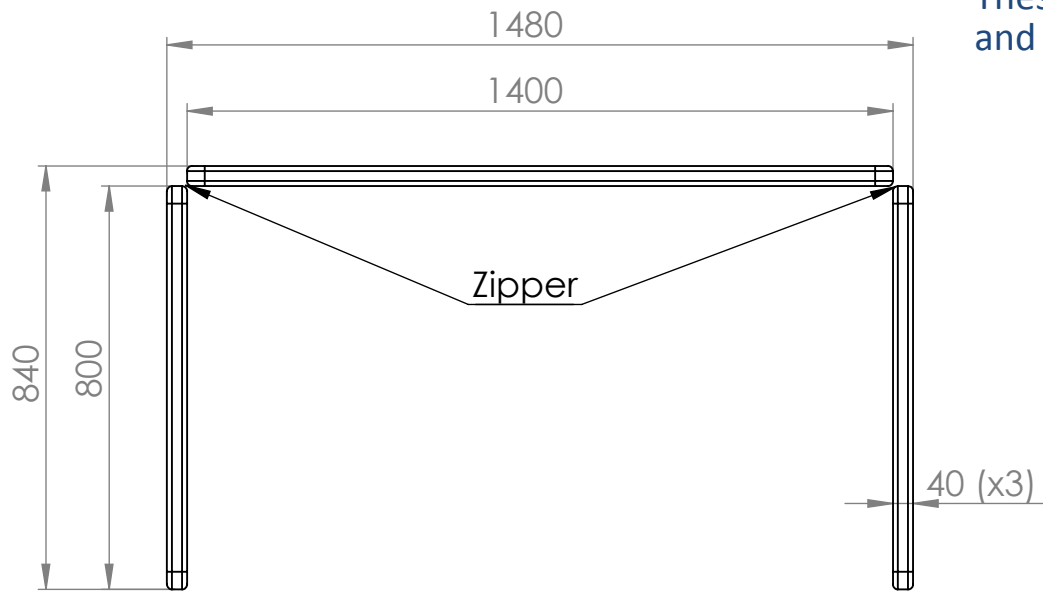
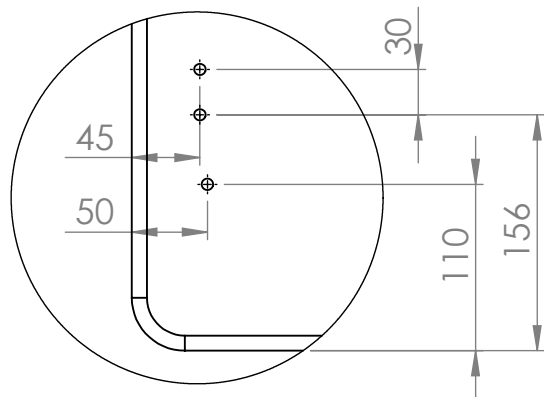

Material	x	Art.nr.	855140	Blad	1/1	A4
Skala	1:15	Sign.	Tolle	Benämning	ScreenIT A30 table booth 1400x650	
		Datum	2017-12-18	Rev	-	